

Varenummer: 207321M6813ST
Beskrivelse: E+G Pasbolt
GN 732.1-M6-8-13-ST

Mål

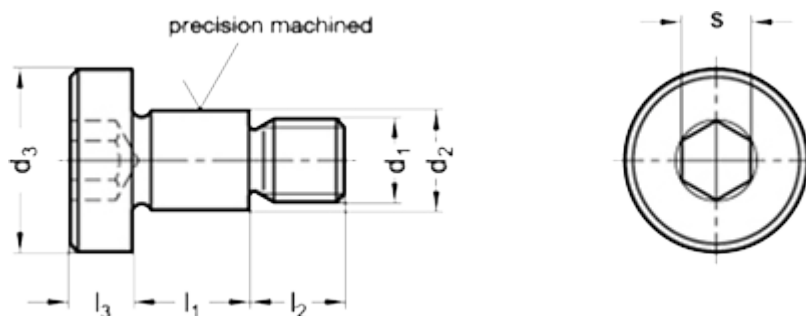

Application example



d1	= M 6
d2	= 8 -0.05/-0.08
d3	= 14
$l_1 +0.20/+0.13$	= 13
l_2	= 8
l_3	= 4
s	= 4
Vægt i (g)	= 10